

IC54 - Undercounter Ice Machine - 54kg / 24hr

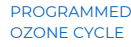

Features

- Steel casing
- Air and water condensation
- Sanitisation cycle
- Programmable ice production
- Capacitive control key
- Audible and light signaling alarms
- HACCP alarm report
- External cube weight adjustment
- USB connection for software update and HACCP data download
- Condenser fan controlled at low ambient temperatures
- Programmable ice production
- Predictive failure analysis
- Equipment performance report

Optional

- Sanitisation cycle programmable with ozone
- Nanotechnological evaporator treatment with Rainbow Technology
- IoT cloud connection
- Feet kit 100mm

Specifications

Ice Types

Shape	Deposit	Pcs	Weight
Cube	22,0 Kg	36	20KG
20 g	1100 Pcs		
-54			
35x32x37mm			

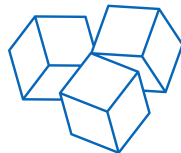

Machine	500 x 590 x 800 (L x W x H (mm))
Shipping	560 x 640 x 960 (L x W x H (mm))
Voltage	220-240/50/1 220/60/1
Gas	R290 GWP 3

Technical Data



Cond.



Comp.



WABS. W



Fuse



Kwh/100Kg



I / h



Kg



Kg

C28A AG220-240/50/1N



1167

520

10

23.3

4.5

42

50



01869 247 947



www.icecoolserVICING.co.uk



Unit 5 Copse Business Centre, Bulls Copse Road, Hounslow
Business Park, Totton, Southampton, SO40 9LR

Dimensions

Front view

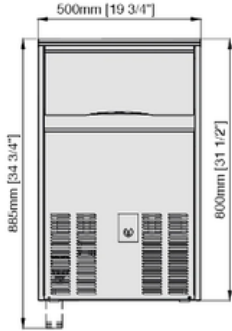

Free space
150 mm **Lateral view**

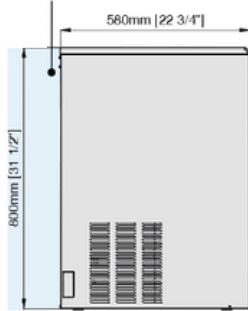

Top view

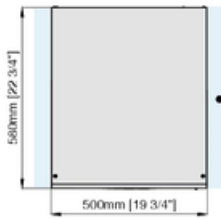

Free space
50 mm

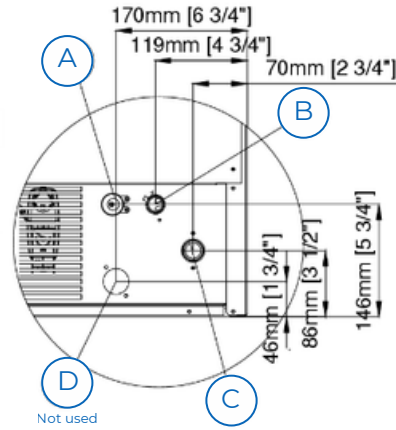

Not used

-  Electrical supply cable
-  Water outlet connection \varnothing 20mm (drain)
-  Water inlet connection 3/4 "G
-  UK 3 pin plug
-  Kit 4 Feet
50mm H100-120mm (optional)

Ice Production

Air cooled unit



Air Temp.

Water Temp.

$^{\circ}\text{C} / ^{\circ}\text{F}$	10° 50°	15° 59°	21° 70°	32° 90°
10°	54	53	49	42
50°	119	117	108	93
21°	46	45	41	35
70°	101	99	90	77
32°	43	42	38	32
90°	95	93	84	71
38°	39	38	34	28
100°	86	84	75	62

MyICE

Allow control and monitoring of ice makers directly from smartphone.



Touch Control

Capacitive Stand-by / Start button (LED continuously changing colors from white to red)



Heat Expelled 1707 W

Air Volume 310 m³/h

Operating Conditions

Temp. Ambient	Min 10°C	Max 40°C
Temp. Water Ice	5°	35°
Press. Water	1 Bar (14psi)	10 Bar (140psi)
Conducib. Water	20 microS	500 microS
Power Supply	-10%	+10%



01869 247 947



www.icecool servicing.co.uk



Unit 5 Cope Business Centre, Bulls Copse Road, Hounslowdown
Business Park, Totton, Southampton, SO40 9LR